

SPIROTECH SPECIFICATION SHEET



Product: SpiroVent Superior
 Customer:
 Project:
 Reference:

Type: S600-B
 MV06B60
 Date: 6/17/2020

Design criteria

Medium:	Water / glycol (max 40%)
Processing Capacity:	1000 l/h
Max system volume:	325 m ³
Min. Pressure:	2.5 bar-g
Max. pressure:	6 bar-g
Min. Temperature:	0 °C
Max. temperature:	90 °C
Ambient temperature	0-40 °C
Refill fluid temperature:	0-60 °C
Refill fluid pressure:	1-10 bar-g
Main pump:	Multistage centrifugal
Break tank suitable for:	Cat. 5 fluid

Connections (flexible)

Inlet / outlet: G3/4"
 Refill: G3/4"

Testing and quality assurance

Running test:	yes
Test medium:	Water
High voltage test:	yes
Test certificate:	no
CE-marking:	yes
Material certificates (structural parts):	no

Construction materials

Vessel:	S235 JRG2
Fittings / hoses:	Brass / EPDM
Pump:	AISI304/Coated cast iron
Deaeration cap:	Brass
Valve sealing:	Viton
Float:	PP
Casing:	Synthetic (PS and EPP)
Color:	Yellow (RAL 1003) and black

Interface

Touch screen:	yes
Wired LAN	yes
Wifi:	option
Remote monitoring and control:	yes
Data encryption:	yes

Drawing

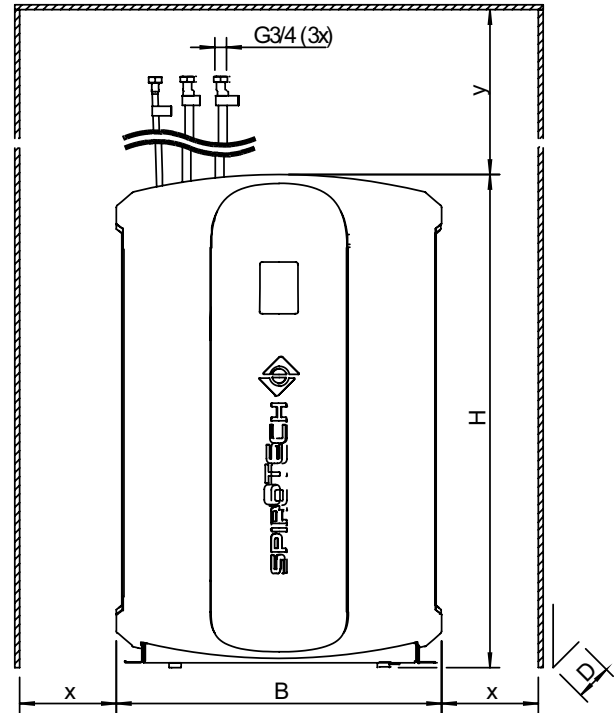

Dimensions

H:	1020 mm
B:	673 mm
D:	360 mm
x:	>600 mm
y:	>600 mm
Dry weight (approx):	63.8 kg
Noise level:	57 db(A)

Power supply

Voltage:	230V / 60Hz
Power consumption:	0.8 kW
Protection level	IP44

B.M.S. Contacts

Boiler interlock:	Voltage free
Common fault:	Voltage free
Communication:	RS485
Remote refill:	5 VDC

Subject to changes